

GB2



Spur Reduction Gearheads - 0.3 Nm

Design

Design In GB2 gearhead ,spur gears rotate on hardness steel spindles which are polished to a mirror finish. In order to damp running noise at slow running times and low motor loads,the initial spur gears after the rotor shaft are made of injection moulded poly acetal. The spur gears close to the output shaft on the other hand,are made of metal.The output shaft is mounted in two special brass bushes. The entire gear train is put between metal plates with a plastic frame. It is permanently lubricated and therefore requires no maintenance. Thicker shaft (06-7mm) mounted in robust bushing (012) are available in new variant (GB2S).

Features

Design In GB2 gearhead ,spur gears rotate on hardness steel spindles which are polished to a mirror finish. In order to damp running noise at slow running times and low motor loads,the initial spur gears after the rotor shaft are made of injection moulded poly acetal. The spur gears close to the output shaft on the other hand,are made of metal.The output shaft is mounted in two special brass bushes. The entire gear train is put between metal plates with a plastic frame. It is permanently lubricated and therefore requires no maintenance. Thicker shaft (06-7mm) mounted in robust bushing (012) are available in new variant (GB2S). Single-way or two way slipping clutches can also be installed to enable the output shaft to be rotated while the motor is stationary. GB2 can also be combined with small DC Motors. To achieve higher gear torque, GB2 can be mounted on GB4.

Application

Timers, Chart Recorders, Potentiometer Drives, Light Displays, Hour Meters, Cam Timers, Programming Devices and Control Instrumentation.

Options

Design In GB2 gearhead ,spur gears rotate on hardness steel spindles which are polished to a mirror finish. In order to damp running noise at slow running times and low motor loads,the initial spur gears after the rotor shaft are made of injection moulded poly acetal. The spur gears close to the output shaft on the other hand,are made of metal.The output shaft is mounted in two special brass bushes. The entire gear train is put between metal plates with a plastic frame. It is permanently lubricated and therefore requires no maintenance. Thicker shaft (06-7mm) mounted in robust bushing (012) are available in new variant (GB2S). Single-way or two way slipping clutches can also be installed to enable the output shaft to be rotated while the motor is stationary. GB2 can also be combined with small DC Motors. To achieve higher gear torque, GB2 can be mounted on GB4.

Standard Data

Parameter	Value	Unit
Gear type	Spur	
Gear Torque	0.3	Nm
Combination with Mechtex motors	Motor MT0,MT6,MTR/S3a/3b,MTR/S-5 and small DC motors	
Mounting	any position	
Weight	60	g
Axial thrust	20	N
Lateral force	50	N
Radial torque	0.5	Nm
Slipping clutches/free wheel	single left/right	
Slipping clutches/friction 2 way	0.05	Nm
Output bearing	Sintered bronze sleeve bushings	
Output shafts	3.175,4.00,4.76,5.00,6.00 & 7.00 (others on request)	Ø
Ambient temperature operation	-15...+ 55	°C
Enclosure	40	IP

Technical Data

Parameter	Value	Unit
Shaft type	OU	-
D (+0.00/-0.10)	12	
H	3.5	
L	54	
d (dia)	6	
I	18	
d	5.4	
P		
M		
T		
h		
C		

dimensional drawing

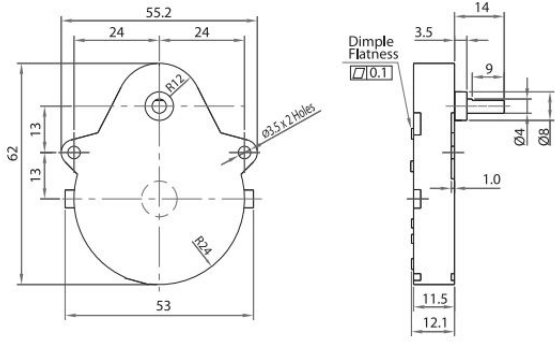

Shaft Drawing

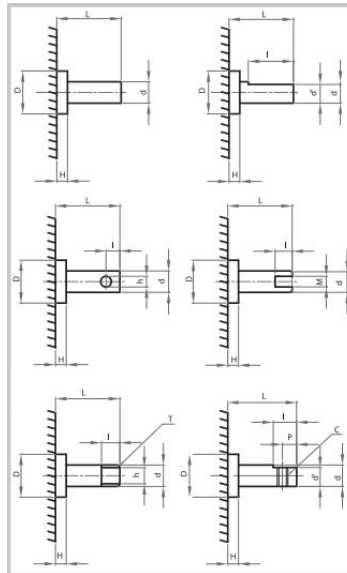

Assembly Drawings

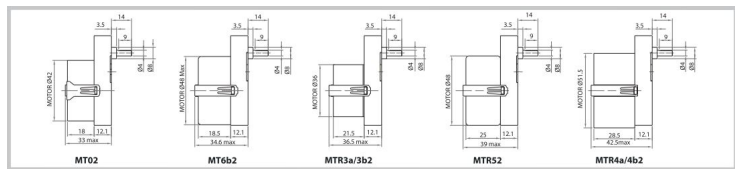

Torque/Transmission Ratio/Life graph

