

GBLk

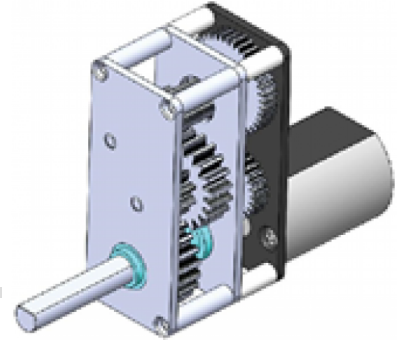

Spur Reduction Gearhead - 0.1 Nm....0.2Nm

Design

Gearhead GBLk contains combination of both metal and polyacetal gears to endure higher torques at moderate speed. The sturdy design of this gearhead makes it durable. This Gearhead has cross section measuring only 12 x 28 x 16 mm (0.47" x 1.1" x 0.63"). GBLk miniature gearhead is available in wide range of gear ratios from 16:1 to 1014:1. GBLk can be combined with brushed DC motors up to dia 12 mm. Versions of these geared motors are available with an optional extended motor shaft, which allows for fitment of encoders on it.

Standard Data

Parameter	Value	Unit
Gear type	Spur/Helical	
Gear Torque	0.1....0.2	nm
Combination with Mechtex motors	N-20 Brushed DC Motors (speed from 5000 to 30,000 rpm)	
Mounting	any position	
Weight	25-35	g
Axial thrust	10	N
Lateral force	20	N
Radial torque	0.2 max	NM
Output bearing	sleeve bushings	
Output shafts	3 mm	Ø
Ambient temperature operation	-15 + 55	°C
Enclosure	20(standard)	IP
Enclosure on special request	40 (with change in profile dimensions)	IP

Technical Data

Parameter	Value	Unit
Voltage	6	vdc
No load Speed	15000	rpm
Dimension(Dia x Height)	12/10x15	mm

Dimensional drawing

